

Strain Gauge

Verification Instructions

for Kit P/N PBT-123

NOTE: Use of a Verification Kit does not change how the strain gauge operates. The PBFT Strain Gauge (located on PBFT machines equipped with either a Model 342 Chart Recorder or an SPC Software Package) operates the same before and after a verification test.

Purpose

Use these instructions to verify the PBFT strain gauge is functioning within normal operating parameters. Strain gauge verification is accomplished by setting a consistent line length (for each hanging weight included in the kit) between the PBT pulley extension arm and the PBFT base plate and noting the value displayed on the strain gauge.

These instructions are intended for use by qualified operator personnel when installing this kit on the PBFT: Strain Gauge Verification Kit (P/N PBT-123)

Scope of Supply

Kit PN PBT-123

- Weights (20, 50, 100, and 200 grams) with weight line and hook ring
 - Pulley Extension Arm
 - Gauge Block
 - Verification Instructions
-



Equipment Required

- DVM with a 20V range and resolution to 1 millivolt (accuracy 0.05% or better)
- Input voltage source (use strain gauge)

Part Identification

Figure 1: Kit PN PBT-123 shown installed on PBFT.

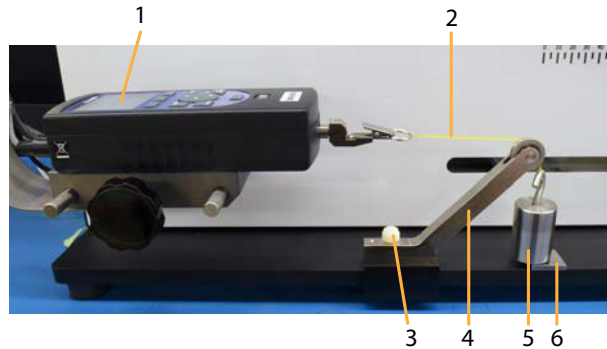

1	Strain Gauge display
2	Weight Line
3	Lock Screw
4	Pulley Extension Arm
5	Weight
6	Gauge Block

Using Verification Kit

To verify normal strain gauge function:

1. Install kit on PBFT per [Kit Installation Procedure](#) (pg 2).
2. [Verify Strain Gauge Display and Millivolt Outputs](#) (pg 4).

Kit Installation Procedure

Prepare PBFT and Strain Gauge

1. Turn on the PBFT power switch.
2. Power on the strain gauge by pressing and holding the strain gauge ON button until display appears.

⚠ CAUTION: DO NOT strike or jar the strain gauge. Apply pressure to the strain gauge clip in a pulling or pushing motion, not by hitting or jarring it. Applying force to this precision instrument at an excessive speed may result in permanent damage to unit.

3. Verify the strain gauge unit of force is set to 'kg'. If it is not set to 'kg', select 'kg' with the UNIT button.
4. With no load on the strain gauge, press the ZERO button to reset the strain gauge to zero. The display should read zero (0).

Install Strain Gauge Verification Kit

Kit PN PBT-123

1. Slide the pulley extension arm onto the PBFT base plate, positioning the arm so a weight will hang freely.
2. Carefully hang a weight over the extension arm, clipping the weight line in the tape clip.
3. Position the gauge block between the PBFT base plate and the hanging weight.

Figure 2: Weight resting lightly on gauge block.

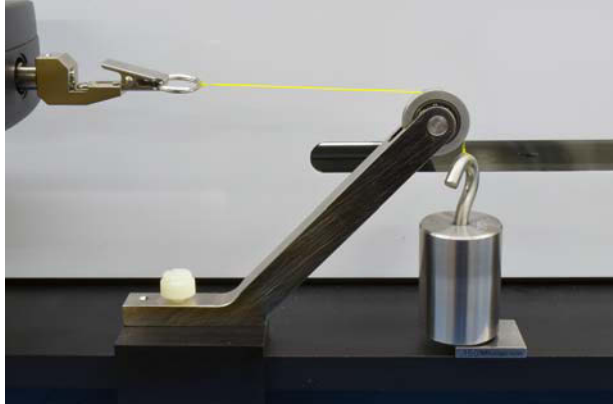

4. As needed, adjust the length of the weight line so the weight rests lightly on the gauge block.
5. Secure the pulley extension arm position by tightening the lock screw.
6. Slide the gauge block out from under the hanging weight and then note the value displayed on the strain gauge. The displayed value should be within a tolerance of 0.02% of the mass of the Class F hanging weight.

Figure 3: Gauge block moved aside.

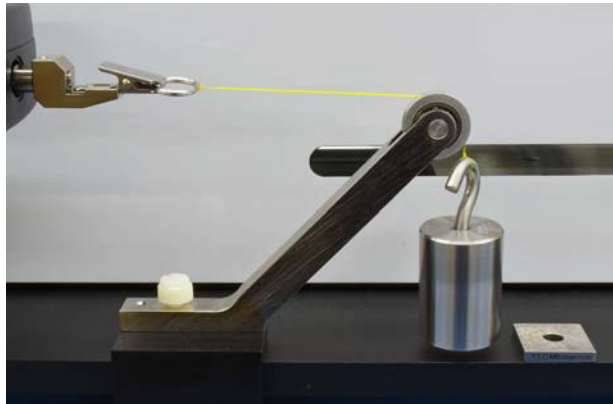

7. Repeat steps 2 through 6 for each of the remaining weights in the kit.

Verify Strain Gauge Display and Millivolt Outputs

CAUTION: DO NOT apply more than one (1) kilogram of force to the strain gauge clip. Applying excessive weight to this clip, which measures the peel back force of the cover tape, may result in permanent damage to the unit.

To verify the strain gauge is performing in linear fashion:

1. Take voltage readings applicable to your PBFT configuration:

Table 1: Instructions Vary by PBFT Configuration

SPC Software	USB Port	Chart Recorder	How to take voltage readings for this configuration:
YES	YES	NO	<p>12-pin Connector - disconnect the data output cable from the strain gauge and then take a voltage reading across pins 11 and 12 of the strain gauge connector.</p> 
YES	NO	NO	<p>15-pin Connector - take a voltage reading at pins 1 and 2 of the PBFT connector into which the software cable plugs.</p>  <p>9-pin Connector - take a voltage reading at pins A and B of the PBFT connector into which the software cable plugs.</p> 

Table 1: Instructions Vary by PBFT Configuration

SPC Software	USB Port	Chart Recorder	How to take voltage readings for this configuration:
NO	NO	YES	<p>Chart Recorder - take a voltage reading at the connections on the rear of the chart recorder at Channel 1 (+) and Channel 1 (—).</p> <p>Rear Terminal Connections:</p> 

2. With zero (0) grams (no weights), the strain gauge should display 0.000 kilograms and measure less than 5 millivolts.

Voltage measured at the connector on the side of the PBFT should be at or near zero (0) volts. Older strain gauge models typically have a + or – voltage (with zero weight) which could vary from one unit to the next. This “offset” voltage is neutralized with circuits in the chart recorder and/or the SPC amplifier assembly. **Make note of this offset voltage and its polarity.**

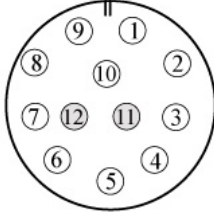
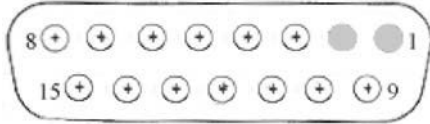
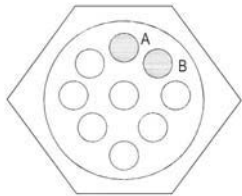
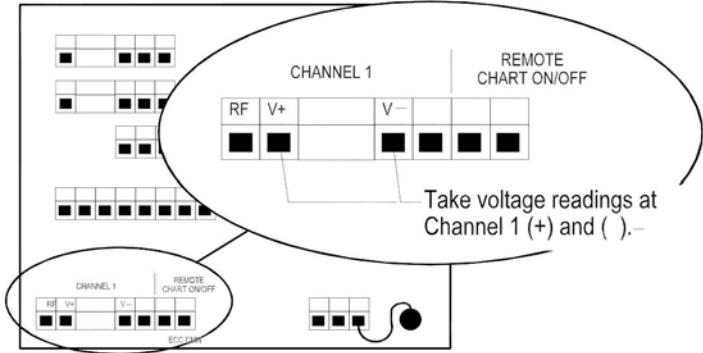
3. Verify the display and output for each weight per [PBFT Weights & Output Values](#) (pg 5).
4. If verification results are satisfactory, the verification process is complete and the hardware may be returned to normal operations. If verification results are not satisfactory, the strain gauge must be re-calibrated; if displayed value is outside the noted tolerance, the strain gauge may need repairs.

IMPORTANT: If verification results are unsatisfactory (if the readings are not within the afore-mentioned voltage range, and if the strain gauge display values are not within the afore-mentioned range of grams), contact the GPD Global Service Department to arrange for re-calibration of the strain gauge

PBFT Weights & Output Values

To verify the strain gauge display and output:

1. Attach the smallest weight from your kit to the PBFT per [Kit Installation Procedure](#) (pg 2).



CAUTION: Support the weight while laying its line over the arm's pulley and clipping the hook ring in the tape clip.



CAUTION: GENTLY release the weight load onto the strain gauge.

- The strain gauge should display the value noted here associated with the weight loaded:

Weight Loaded	Displayed Value should be:
20 grams	0.020 kilograms ± 0.003 kg
50 grams	0.050 kilograms ± 0.003 kg
100 grams	0.100 kilograms ± 0.003 kg
200 grams	0.200 kilograms ± 0.003 kg

- Measure the voltage and polarity.
- Subtract the offset voltage previously measured in [Step 2 \(pg 5\)](#). Make note of the resulting new voltage.

Weight Loaded	New Voltage represents:
20 grams	20 grams.
50 grams	50 grams.
100 grams	100 grams. Twice the voltage of the 50 gram weight ± 0.015 volts.
200 grams	200 grams. Twice the voltage of the 100 gram weight ± 0.015 volts.

- Remove the weight.
- Attach the next heaviest weight from the kit and perform the above procedure beginning with [Step 2 \(pg 6\)](#).
- Repeat until you have verified all weights in the kit.

PBFT Weight Declaration

PBFT Weight Declaration

Issued by:
GPD Global®

Equipment: * Peel Back Force Tester
* Strain Gauge Verification Kit
* 20, 50, 100, and 200 Gram Weights

Part Nos: PBT-0589 (20 gram weight)
PBT-0505 (50 gram weight)
PBT-0506 (100 gram weight)
PBT-0507 (200 gram weight)

Declaration: All weights are within $\pm 0.02\%$ of